

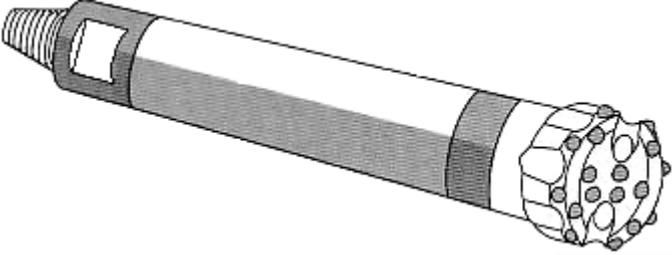



 <p>HCD64—DHD360 shank HCD64---COP64 shank/HCD64---SD6 shank</p>	<p>Hammer Length without bit(mm): 1312 Thread: 3-1/2API REG Outside diameter(mm): 142 Wrench flat(mm): 95 Weight(kg): 124 Work pressure(bar): 6-25 Air consumption L/s blank choke: 10bar 18bar 24bar 175L/s 342L/s 475L/s</p>
 <p>HCD84---DHD380 shank</p>	<p>Hammer Length without bit(mm): 1458 Thread: 4 1/2 API REG Outside diameter(mm): 160 Wrench flat(mm): 140 Weight(kg): 155 Work pressure(bar): 6-25 Air consumption L/s blank choke: 10bar 18bar 24bar 176L/s 345L/s 480L/s</p>





High pressure DTH bit





3 inch high pressure DTH hammer						
Shank style	Diameter mm	Air holes	Guage buttons	Front buttons	Weight kg	Part No
 <p>COP32</p>	85	2	6 x 13	4 x 12	4.2	Cop32-85
	90	2	6 x 14	4 x 12	4.5	Cop32-90
	95	2	6 x 14	4 x 13	4.7	Cop32-95
	100	2	8 x 12	6 x 12	5.0	Cop32-100
	105	2	8 x 13	6 x 12	5.3	Cop32-105
 <p>BR3</p>	85	2	6 x 13	4 x 12	3.8	Br3-85
	90	2	6 x 14	4 x 12	4.0	Br3-90
	95	2	6 x 14	4 x 13	4.3	Br3-95
	100	2	8 x 12	6 x 12	4.8	Br3-100
	105	2	8 x 13	6 x 12	5.2	Br3-105

3 inch high pressure DTH hammer						
Shank style	Diameter mm	Air holes	Guage buttons	Front buttons	Weight kg	Part No
IR3.5、COP34 	85	2	6 x 13	4 x 12	4.2	DHD3.5-85
	90	2	6 x 14	4 x 12	4.5	DHD3.5-90
	95	2	6 x 14	4 x 13	4.8	DHD3.5-95
	100	2	8 x 12	6 x 12	5.0	DHD3.5100
	105	2	8 x 13	6 x 12	5.5	DHD3.5-105
XL3 	85	2	6 x 13	4 x 12	4.5	XL3-85
	90	2	6 x 14	4 x 12	4.7	XL3-90
	95	2	6 x 14	4 x 13	4.9	XL3-95
	100	2	8 x 12	6 x 12	5.0	XL3-100
	105	2	8 x 13	6 x 12	5.5	XL3-105



4 inch high pressure DTH hammer						
Shank style	Diameter mm	Air holes	Guage buttons	Front buttons	Weight kg	Part No
DHD340A、COP44 	105	2	6 x 14	5 x 13	8.5	DHD340-105
	110	2	7 x 13	6 x 13	8.8	DHD340-110
	115	2	7 x 14	6 x 13	9.0	DHD340-115
	120	2	8 x 14	6 x 14	9.8	DHD340-120
	127	2	8 x 14	7 x 14	11.5	DHD340-127
SD4 	105	2	6 x 14	5 x 13	9.0	SD4-105
	110	2	7 x 13	6 x 13	9.5	SD4110
	115	2	7 x 14	6 x 13	9.8	SD4-115
	120	2	8 x 14	6 x 14	11.5	SD4-120
	127	2	8 x 14	7 x 14	12.3	SD4-127
QL40 	105	2	6 x 14	5 x 13	9.0	QL40-105
	110	2	7 x 13	6 x 13	9.2	QL40-110
	115	2	7 x 14	6 x 13	9.5	QL40-115
	120	2	8 x 14	6 x 14	10.3	QL40-120
	127	2	8 x 14	7 x 14	11.5	QL40-127

4 inch high pressure DTH hammer						
Shank style	Diameter mm	Air holes	Guage buttons	Front buttons	Weight kg	Part No
 <p>Mission40</p>	105	2	6 x 14	5 x 13	6.0	M40-105
	110	2	7 x 13	6 x 13	6.2	M40-110
	115	2	7 x 14	6 x 13	6.6	M40-115
	120	2	8 x 14	6 x 14	7.0	M40-120
	127	2	8 x 14	7 x 14	7.4	M40-127

5 inch high pressure DTH hammer						
Shank style	Diameter mm	Air holes	Guage buttons	Front buttons	Weight kg	Part No
 <p>DHD350R、COP54</p>	133	2	7 x 16	6 x 14	15.0	DHD350-133
	140	2	7 x18	7 x14	16.0	DHD350-140
	146	2	8 x18	7 x 14	17.0	DHD350-146
	152	2	8 x 18	8 x 14	17.5	DHD350-152
	165	2	8 x 18	8 x 16	18.5	DHD350-165
 <p>SD5</p>	133	2	7 x 16	6 x 14	15.5	SD5-133
	140	2	7 x18	7 x14	16.0	SD5-140
	146	2	8 x18	7 x 14	16.5	SD5-146
	152	2	8 x 18	8 x 14	17.0	SD5-152
	165	2	8 x 18	8 x 16	18.0	SD5-165
 <p>QL50</p>	133	2	7 x 16	6 x 14	15.5	QL50-133
	140	2	7 x18	7 x14	16.0	QL50-140
	146	2	8 x18	7 x 14	16.5	QL50-146
	152	2	8 x 18	8 x 14	17.0	QL50-152
	165	2	8 x 18	8 x 16	18.0	QL50-165
 <p>Mission50</p>	133	2	7 x 16	6 x 14	12.5	M50-133
	140	2	7 x18	7 x14	13.5	M50-140
	146	2	8 x18	7 x 14	14.0	M50-146
	152	2	8 x 18	8 x 14	14.4	M50-152
	165	2	8 x 18	8 x 16	15.0	M50-165



6 inch high pressure DTH hammer						
Shank style	Diameter mm	Air holes	Guage buttons	Front buttons	Weight kg	Part No
DHD360、COP64 	152	2	8 x 16	8 x 16	22.0	DHD360-152
	165	2	8x 18	8 x 16	26.0	DHD360-165
	175	2	8 x18	8 x 18	27.0	DHD360-175
	190	3	9 x 18	9 x 16	28.5	DHD360-190
	203	3	9 x 18	9 x 18	29.5	DHD360-203
SD6 	152	2	8 x 16	8 x 16	26.0	SD6-152
	165	2	8x 18	8 x 16	27.0	SD6-165
	175	2	8 x18	8 x 18	29.0	SD6-175
	190	3	9 x 18	9 x 16	32.0	SD6-190
	203	3	9 x 18	9 x 18	34.0	SD6-203
QL60 	152	2	8 x 16	8 x 16	24.0	QL60-152
	165	2	8x 18	8 x 16	25.0	QL60-165
	175	2	8 x18	8 x 18	27.0	QL60-175
	190	3	9 x 18	9 x 16	29.0	QL60-190
	203	3	9 x 18	9 x 18	33.0	QL60-203
Mission60 	152	2	8 x 16	8 x 16	22.0	M60-152
	165	2	8x 18	8 x 16	23.0	M60-165
	175	2	8 x18	8 x 18	24.0	M60-175
	190	3	9 x 18	9 x 16	25.5	M60-190
	203	3	9 x 18	9 x 18	28.0	M60-203

8 inch high pressure DTH hammer						
Shank style	Diameter mm	Air holes	Guage buttons	Front buttons	Weight kg	Part No
DHD380、COP84 	195	3	9 x18	9 x 16	33.0	DHD380-195
	203	3	9x 18	9 x18	40.0	DHD380-203
	216	2	10 x18	12 x 16	49.0	DHD380-216
	254	3	11 x 18	17x 16	71.0	DHD380-254
	305	4	12 x 18	29 x16	95.0	DHD380-305

 <p>SD8</p>	195	3	9 x 18	9 x 16	32.0	SD8-195
	203	3	9x 18	9 x 18	37.0	SD8-203
	216	2	10 x 18	12 x 16	48.0	SD8-216
	254	3	11 x 18	17x 16	70.0	SD8-254
	305	4	12 x 18	29 x 16	94.0	SD8-305
 <p>QL80</p>	195	3	9 x 18	9 x 16	32.0	QL80-195
	203	3	9x 18	9 x 18	35.0	QL80-203
	216	2	10 x 18	12 x 16	49.0	QL80-216
	254	3	11 x 18	17x 16	71.0	QL80-254
	305	4	12 x 18	29 x 16	95.0	QL80-305
 <p>Mission80</p>	195	3	9 x 18	9 x 16	33.0	M80-195
	203	3	9x 18	9 x 18	38.0	M80-203
	216	2	10 x 18	12 x 16	50.0	M80-216
	254	3	11 x 18	17x 16	74.0	M80-254
	305	4	12 x 18	29 x 16	95.0	M80-305

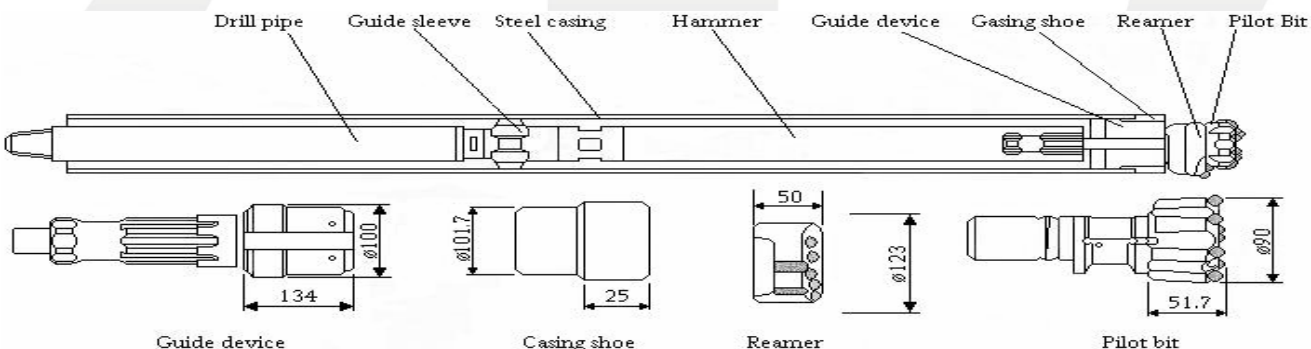
Overburden drilling systems

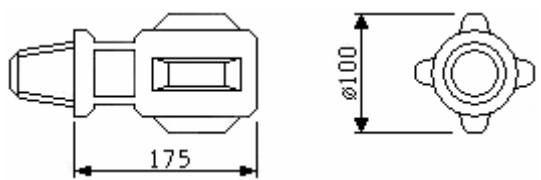
<p>Odex 90</p> 					
<p>Alternative casing may be used: Maximu outside diameter 115mm Minimum insid diameter 102mm</p>					
Description	<table border="1"> <thead> <tr> <th>Weight kg</th> <th>Part No.</th> </tr> </thead> <tbody> <tr> <td> </td> <td> </td> </tr> </tbody> </table>	Weight kg	Part No.		
Weight kg	Part No.				

<p>ODEX 90 System for 3 inc hammer, the shank can be customer request, like DHD3.5,Cop34, etc</p> <p>Guide Device</p> <p>Casing Shoe</p> <p>Eccentric Reamer</p> <p>Pilot Bit</p>	<p>7.8</p> <p>1.1</p> <p>1.35</p> <p>3.6</p>	<p>DXQ9034</p> <p>GX90</p> <p>KZT90123</p> <p>DZT90</p>
<p>Guide sleeve</p> <p style="text-align: right;">API 2-3/8" REG</p>  <p>Wrench flat 65mm</p>	<p>5.8</p>	<p>DLO90</p>
<p>Guide Device Locking Kit , comprising: Three complete sets of 2 pilot bit pin , 2 inside hexangular bolts and 8 locking balls. One pusher for poilot-bit pins.</p> <p>A Pilot bit pin (9.85×60mm)1piece</p> <p>B Inside hexangular bolt (M6×12)1piece</p> <p>C Pusher for pilot-bit pin (7.8×155mm)1piece</p> <p>D Locking balls (9.5mm)1piece</p> 	<p>0.02</p> <p>0.02</p> <p>0.04</p> <p>0.01</p>	<p>9001</p> <p>9002</p> <p>9003</p> <p>9004</p>

Odex 115

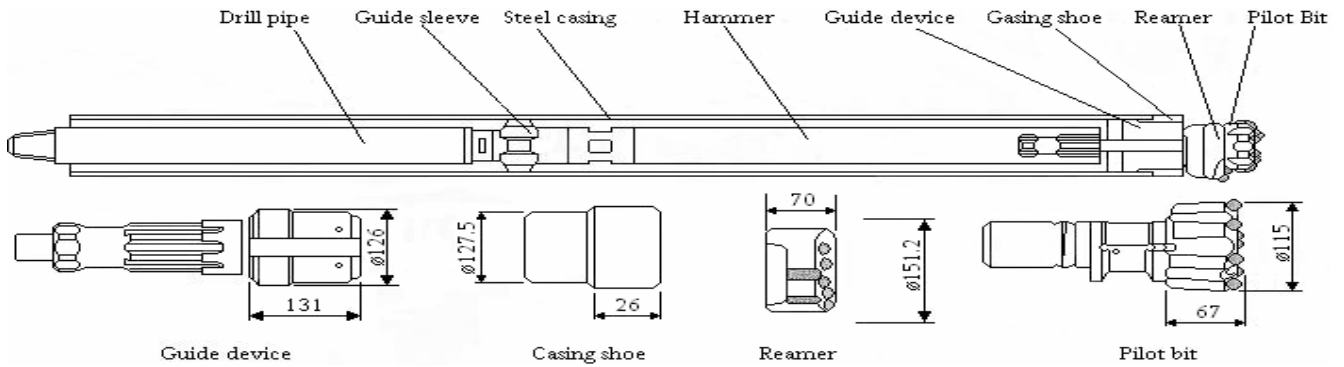

Alternative casing may be used:

Maximum outside diameter

142mm

Minimum inside diameter

128mm

Description	Weight kg	Part No.
ODEX-115 System for 4 inch hammer, the shank can be customer request, like DHD340, Cop 44, SD4, etc Guide Device	11.7	DXQ11544
Casing Shoe	1.6	GX115
Eccentric Reamer	2.6	KZT115151
Pilot Bit	7.8	DZT115
Guide sleeve Wrench flat 65mm	8.3	DLQ115

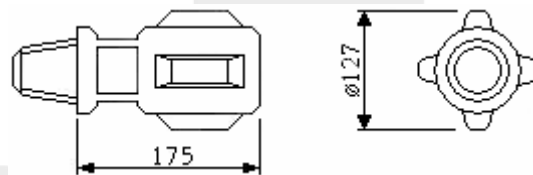

<p>Guide Device Locking Kit , comprising: Three complete sets of 2 pilot bit pin , 2 inside hexangular bolts and 12 locking balls. One pusher for pilot-bit pins.</p>		0.03	11501
A Pilot bit pin	(11.5×75mm)1piece	0.02	11502
B Inside hexangular bolt	(M6×12)1piece	0.4	11503
C Pusher for pilot-bit pin	(10×160mm)1piece	0.01	11504
D Locking balls	(11mm)1piece		

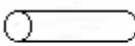

A

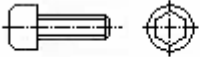

B

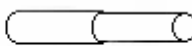

C

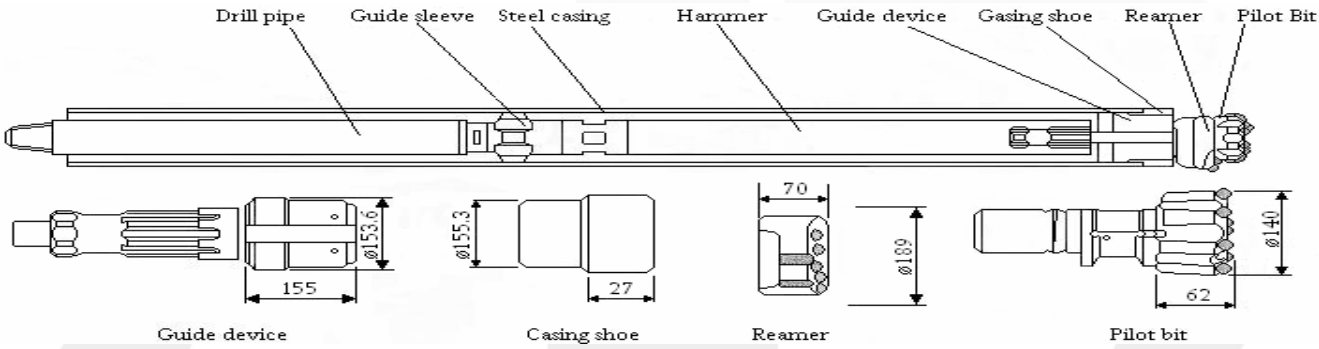

D

<p>Odex 140</p>  <p>Alternative casing may be used: Maximum outside diameter 171mm Minimum inside diameter 155.6mm</p>		
Description	Weight kg	Part No.
ODEX-140 System for 5inch hammer, the shank can be customer's request, like DHD350, COP54, SD5, etc.		
Guide Device	19.7	DXQ14054
Casing Shoe	2.4	GX140
Eccentric Reamer	4.1	KZT140189
Pilot Bit	11	DZT140

Guide sleeve	API 2-3/8" REG	9	DLQ140
Wrench flat 65mm			
Wrench flat 95mm		16.4	DLQ140A
Guide Device Locking Kit , comprising:	API 3-1/2" REG		
Three complete sets of 2 pilot bit pin , 2 inside hexangular bolts and 12 locking balls. One pusher for pilot-bit pins.			
A Pilot bit pin	(11.5×75mm)1piece	0.03	14001
B Inside hexangular bolt	(M6×12)1piece	0.02	14002
C Pusher for pilot-bit pin	(10×160mm)1piece	0.4	14003
D Locking balls	(11mm)1piece	0.01	14004

Odex 165

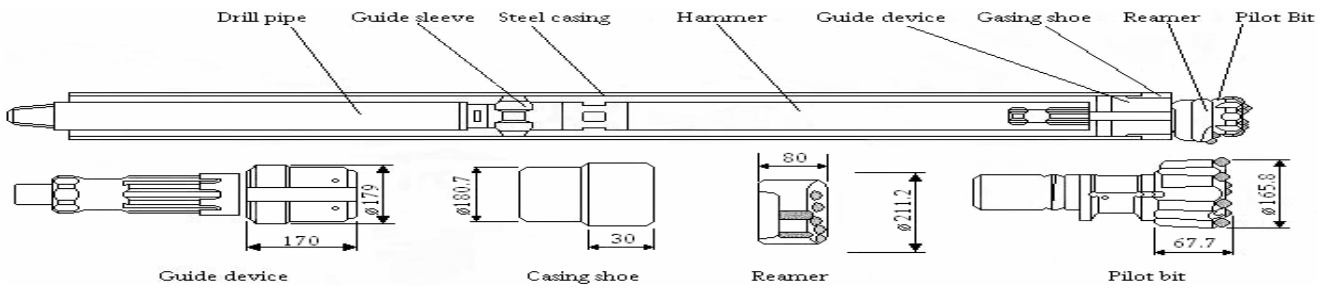

Alternative casing may be used:



Maximum outside diameter

195.6mm

Minimum inside diameter

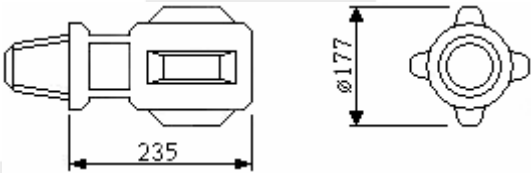
182.5mm

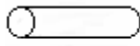
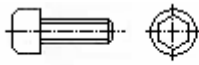
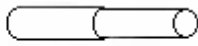
Description	Weight kg	Part No.
ODEX-165 System for 6 inch hammer, the shank can be customer request, like DHD360, COP64, SD6, etc.		
Guide Device	33.5	DXQ16564
Casing Shoe	3.2	GX165
Eccentric Reamer	7.0	KZT165211
Pilot Bit	17	DZT165
Guide sleeve  Wrench flat 95mm	21.5	DLQ165
Guide Device Locking Kit , comprising: Three complete sets of 2 pilot bit pin , 2 inside hexangular bolts and 12 locking balls. One pusher for pilot-bit pins.	0.03	16501
A Pilot bit pin (11.5×75mm)1piece	0.02	16502
B Inside hexangular bolt (M8×12)1piece	0.4	16503
C Pusher for pilot-bit pin (10×160mm)1piece	0.01	16504

D Locking balls				(11mm)1piece		
						
A	B	C	D			

DTH drill rods and adapters

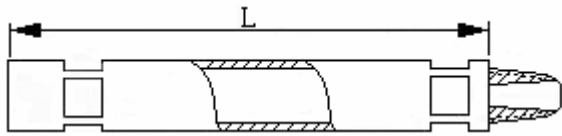
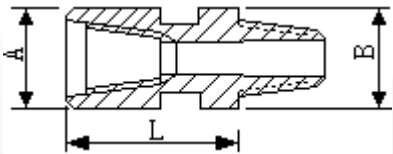
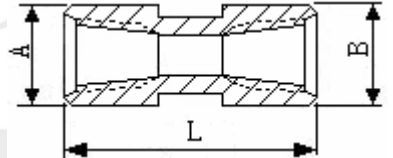
Drill tube						Threads	Wrench flats mm	Length mm	Dia mm		Weight kg	Part No.
						Box x Pin adapters						
												
Threads	Wrench flats mm	Length mm	Dia mm	Weight kg	Part No.							
2-3/8 API REG Wall thickness=5.0mm	57	1000	76	16	ZG761000A	2-3/8 x 2-3/8 API REG	65	140	77	77	4	JT101
	57	1500	76	20	ZG761500A	2-3/8 x 2-3/8 API REG	65	140	90	90	5.5	JT102
	57	2000	76	24	ZG762000A	2-3/8 x 3-1/2 API REG	95	185	102	102	6.5	JT103
	57	3000	76	33	ZG763000A	3-1/2 x 2-3/8 API REG	95	219	115	90	12.5	JT104
2-3/8 API REG Wall thickness=5.0mm	65	1000	76	15	ZG761000B	2-7/8 x 2-3/8 API REG	65	154	90	90	6.5	JT105
	65	1500	76	20	ZG761500B	2-3/8 x 2-7/8 API REG	65	160	115	115	11	JT106
	65	2000	76	24	ZG762000B	3-1/2 x 2-7/8 API REG	95	160	115	115	7.5	JT107
	65	3000	76	33	ZG763000B	3-1/2 x 3-1/2 API REG	95	160	115	115	12	JT108
2-3/8 API REG Wall thickness=6.5mm	65	3000	76	33	ZG763000B	3-1/2 x 4-1/2 API REG	120	132	115	146		JT109
	65	3000	76	40	ZG763000C	4-1/2 x 3-1/2 API REG	95	235	146	115		JT1010
	65	4500	76	56	ZG764500C	Box x Box adapters						
	65	6000	76	73	ZG766000C							
2-3/8 API REG Wall thickness=5.0mm	65	1000	89	18	ZG891000B							
	65	1500	89	23	ZG891500B							
2-3/8 API REG Wall thickness=6.5mm	65	2000	89	28	ZG892000B							
	65	3000	89	38	ZG893000B							
	65	3000	89	38	ZG893000B	2-3/8 x 2-3/8 API REG	65	200	77	77	4.5	JT201
						2-3/8 x 2-3/8 API REG	65	200	90	90	5	JT202
						2-3/8 x 3-1/2 API REG	95	210	90	115	10.5	JT203

Rock drilling tools

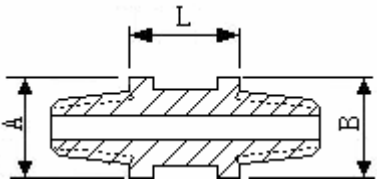
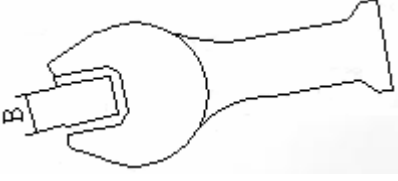
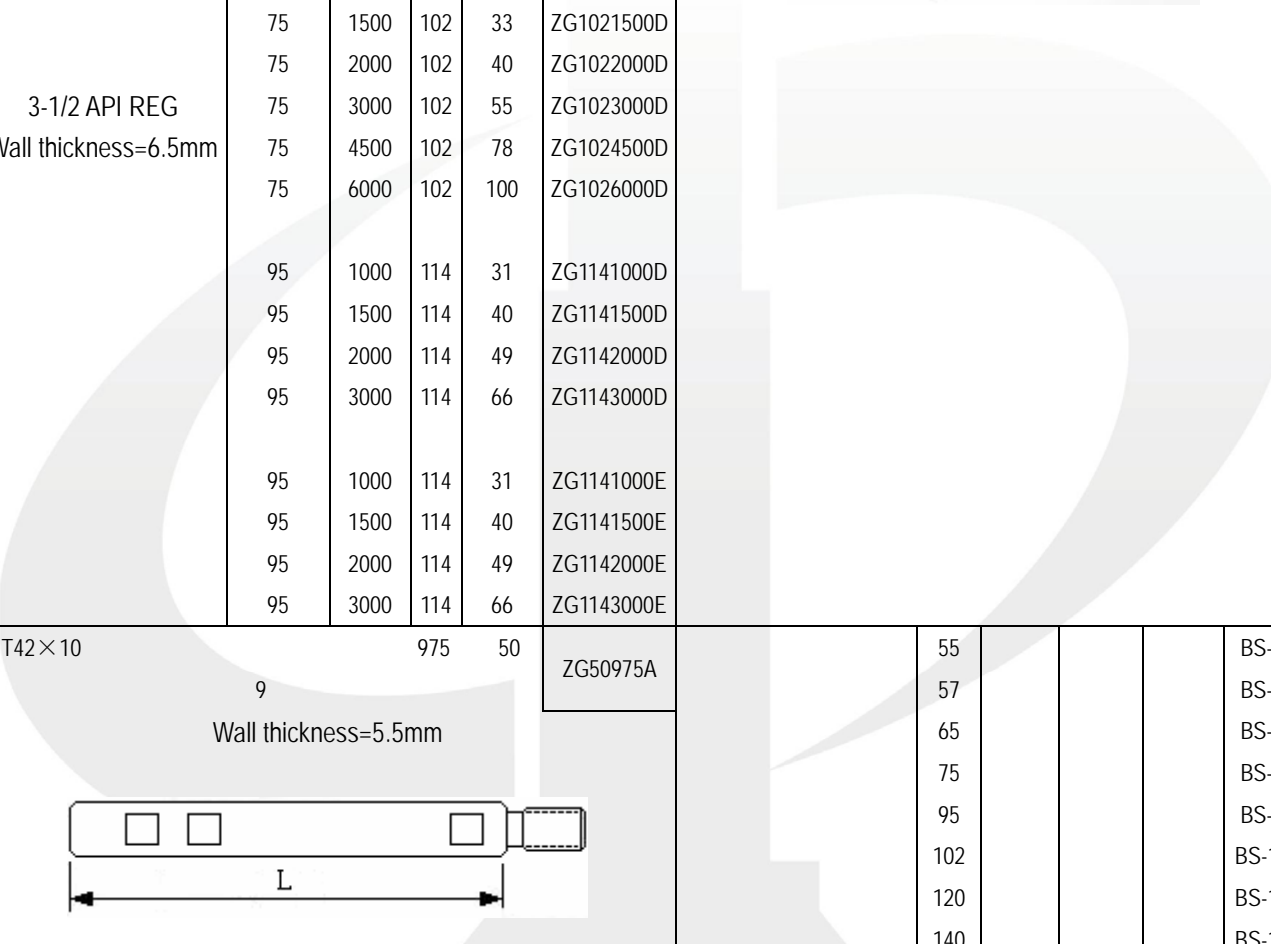
2-7/8 API REG Wall thickness=6.5mm	65	1000	89	20	ZG891000C	<p>Pin×Pin adapters</p> 						
	65	1500	89	26	ZG891500C							
	65	2000	89	32	ZG892000C							
	65	3000	89	45	ZG893000C							
	65	4500	89	65	ZG894500C							
	65	6000	89	84	ZG896000C							
2-7/8 API REG Wall thickness=6.5mm	65	1000	89	20	ZG891000D	2-3/8×2-3/8 API REG	65	70	78	94	5	JT301
	65	1500	89	26	ZG891500D	3-1/2×2-3/8 API REG	95	80	102	90	9	JT302
	65	2000	89	32	ZG892000D	3-1/2×3-1/2 API REG	95	90	115	115	10	JT303
	65	3000	89	45	ZG893000D	<p>Wrenches for hammers and drill pipes</p> 						
	65	4500	89	65	ZG894500D							
	65	6000	89	84	ZG896000D							
75	1000	102	25	ZG1021000D								
3-1/2 API REG Wall thickness=6.5mm	75	1500	102	33	ZG1021500D							
	75	2000	102	40	ZG1022000D							
	75	3000	102	55	ZG1023000D							
	75	4500	102	78	ZG1024500D							
	75	6000	102	100	ZG1026000D							
	95	1000	114	31	ZG1141000D							
95	1500	114	40	ZG1141500D								
95	2000	114	49	ZG1142000D								
95	3000	114	66	ZG1143000D								
95	1000	114	31	ZG1141000E								
95	1500	114	40	ZG1141500E								
95	2000	114	49	ZG1142000E								
95	3000	114	66	ZG1143000E								
T42×10	9	975	50	ZG50975A	55						BS-55	
					57						BS-57	
					65						BS-65	
					75						BS-75	
					95						BS-95	
					102						BS-102	
					120						BS-120	
					140						BS-140	